

eaZI®flex VITROX 200

Swing door hinge | Pendulum hinge glass-glass connection

ORIGIN: RHEINAU, GERMANY

TYPE: EAZI®FLEX

SERIES: VITROX 200

MEDIUM: FLUID

HINGE TYPE: SWING DOOR HINGE

ART.-NO.: H010-00-020

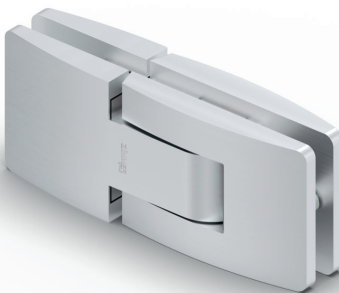

The eaZI®flex VITROX 200 swing hinge is the perfect embodiment of elegant convenience. This innovative swing door hinge is installed as a connecting piece between a fixed part and a glass or wooden door and offers impressive functionality.

Innovative technology and versatility

With the eaZI®flex VITROX 200 pivot hinge, it is possible to open the door both inwards and outwards, up to an angle of 90 degrees. This double-sided opening allows the door to be used *flexibly* in a wide variety of rooms and situations. A particular highlight is the ability to lock the door in any position, which offers additional convenience and *flexibility*.

Automatic and soft closing

Another advantage of the eaZI®flex VITROX 200 is its ability to close automatically from a door position of 70 degrees. Closing is particularly gentle and quiet thanks to the integrated soft-close technology. This ensures that the door moves quietly and centred into the closed position, which is not only functional but also aesthetically pleasing.

Elegant design

The pendulum hinge impresses with its elegant design. The smooth surface gives the hinge a pleasant feel and a visually appealing appearance. With its slim shape and rounded edges, the eaZI®flex VITROX 200 blends harmoniously into the design of any door without being obtrusive. It combines form and function in a way that is both visually and practically appealing.

Convenient handling

The ease of use of the eaZI®flex VITROX 200 is outstanding. A gentle pull on the open door is all it takes to close it gently and quietly. The door rotates effortlessly to the centre and centres itself automatically, which makes handling the door much easier and at the same time conveys a feeling of high quality.

Highest quality from German production

Quality is a top priority at eaZI®flex VITROX 200. All hinges are manufactured in our production facility in Germany, with every single product undergoing 100% quality testing. These rigorous tests ensure that every swing hinge meets the highest standards and guarantees

consistently high product quality. The eaZI®flex VITROX 200 pivot hinge is the ideal choice for your glass and wooden doors. It combines elegant design with maximum convenience and excellent quality, making it an outstanding solution for modern living and working spaces.

Our products are 100% tested

Our products are checked with a camera during production. The use of industrial image processing enables 100% inspection of critical geometric product features and ensures consistent quality.

CO2-neutral power generation: Regional and green

The Zimmer Group obtains all of its electricity from CO2-neutral sources. Part of this energy comes from a regional power plant, while the majority is generated by our own photovoltaic systems. The expansion work for additional photovoltaic modules is in full swing.

TECHNICAL DATA

Technology:	Defined Comfort
Limited use:	no
Field of application:	10-40 °C
Hinge type:	Swing door hinge
Load capacity per hinge:	35 kg
Damping:	Adjustable
Closure from:	70 °
Length:	199 mm
Width:	46 mm
Height:	82 mm
Fastening type on door side:	Clampable
Mounting type On-site:	Clampable
Opening direction:	Double-sided
Opening angle:	90 °
Adjustable zero position :	yes
Setting range:	5 °
Door thickness:	8-13.5 mm
Type of glass:	

DATA SHEET

MATERIAL

Housing material:	Zinc die casting
-------------------	------------------

Housing color:

Housing surface:	powder-coated
------------------	---------------

TEST METHOD

Lifetime :	500,000 Cycles
------------	----------------

Standard 1:	DIN EN 15706
-------------	--------------

Standard 2:	DIN EN 1527
-------------	-------------

Overload test:	10 x 1 m/s
----------------	------------

Endurance test:	500.000 Zyklen 0,25m/s
-----------------	------------------------



GENERAL DATA

Logo:	Zimmer
-------	--------

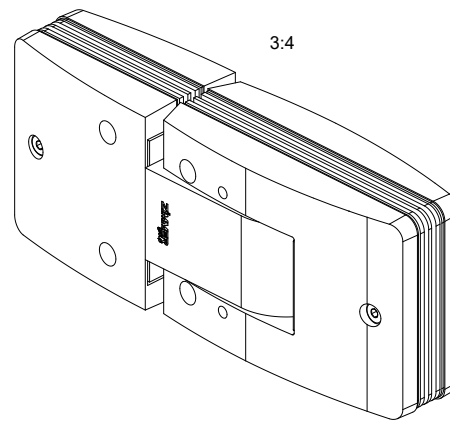
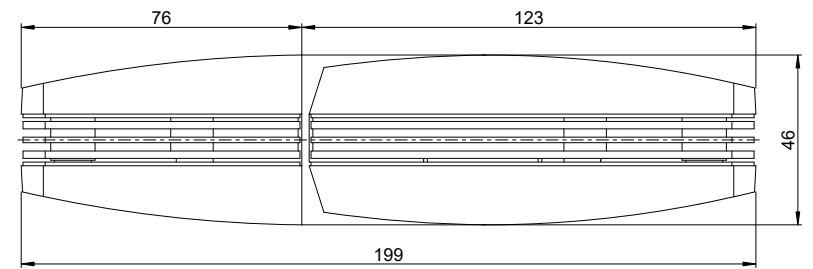
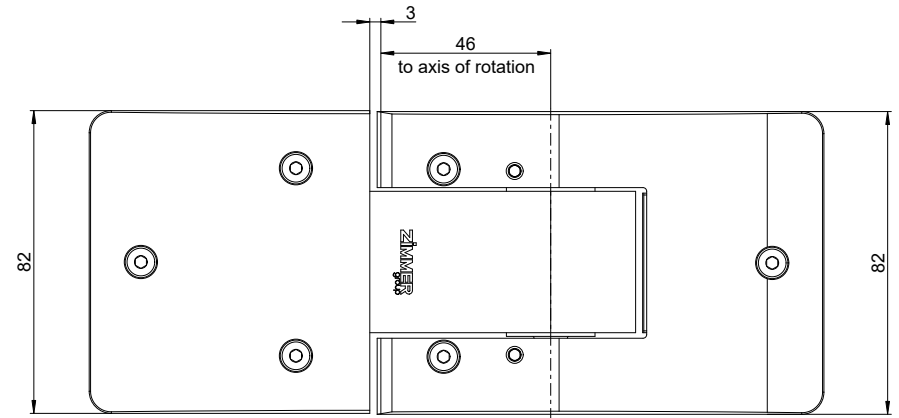
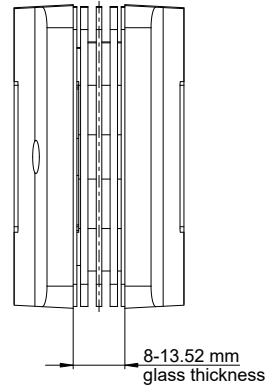
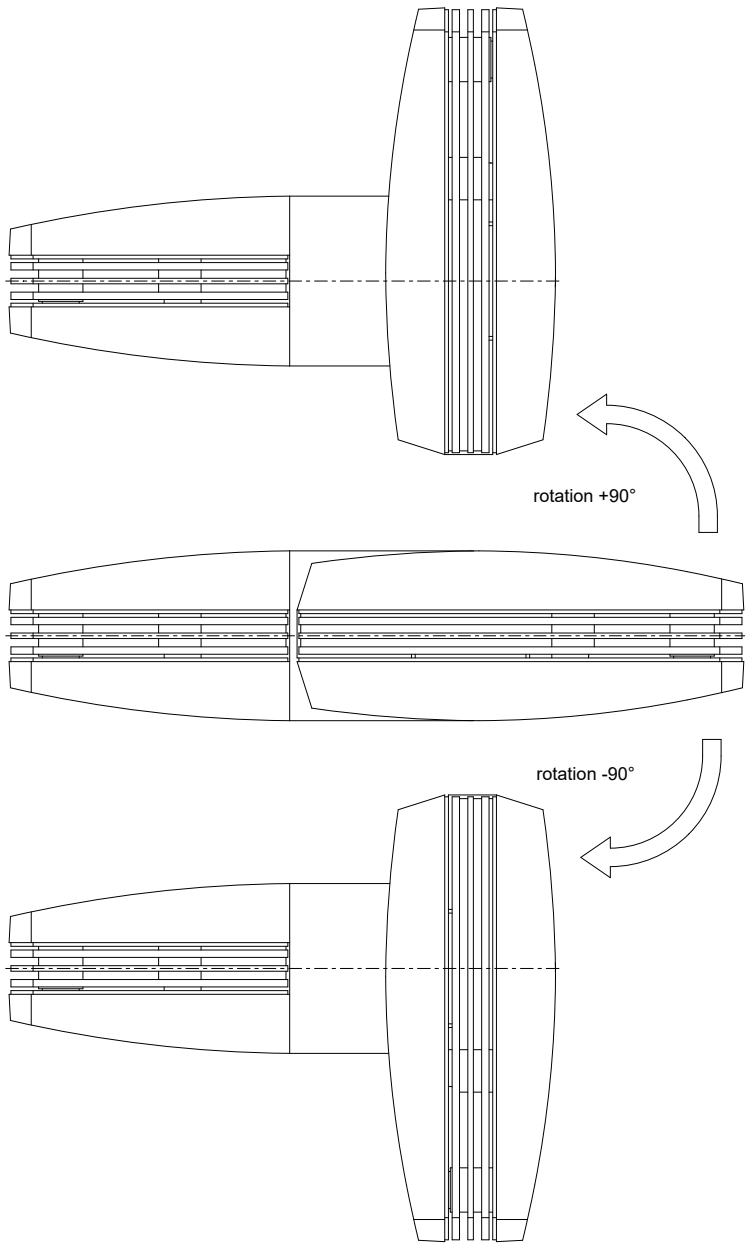
Carton, PU:	1 Piece
-------------	---------



Color: Matte white aluminum

		Allgemeintoleranzen/ standard tolerances ISO 2768:1989 T1-m/T2-K		Maßstab scale: 1:1	Oberfl. surface: -	308564mm ³	Gewicht weight: 2.7189kg
Vertriebsbezeichnung, auch für Ersatzteile, nur mit schriftlicher Genehmigung der Zimmer Group. Reproduction, copying, even in extracts, only with the written approval of Zimmer Group.		Datum/issue date: 04.07.25	Name/name: scramer	Werkstoff material: -	Halbausg. dimension: -	Volumen volume: 458924mm ³	Spalte class: DREHTUER
Kanten nach/Edges according to ISO 13715		checked 09.07.25	Name/name: akraus	Rohstr. part no.: -	Zeichnungsnummer/drawing number H010-00-020_-	eaZiflex VITROX 200 Glas-an-Glas-Befestigung	
projection		norm. 08.05.24	Name/name: akraus		Zeichnungsnummer/drawing number H010-00-020_-		
Ind. Änderung/modification: -	Datum: -	Name: -	Zimmer GmbH Dämpfungssysteme	Freigabestatus/status: 60	Blatt/sheet: 5 v. 5 Bl.	Format: DIN A2	